

Article number: 439600280

Description: Rota-fix shaft-hub connection FS280x355

Note: Self centering - very high torque.

## Measures

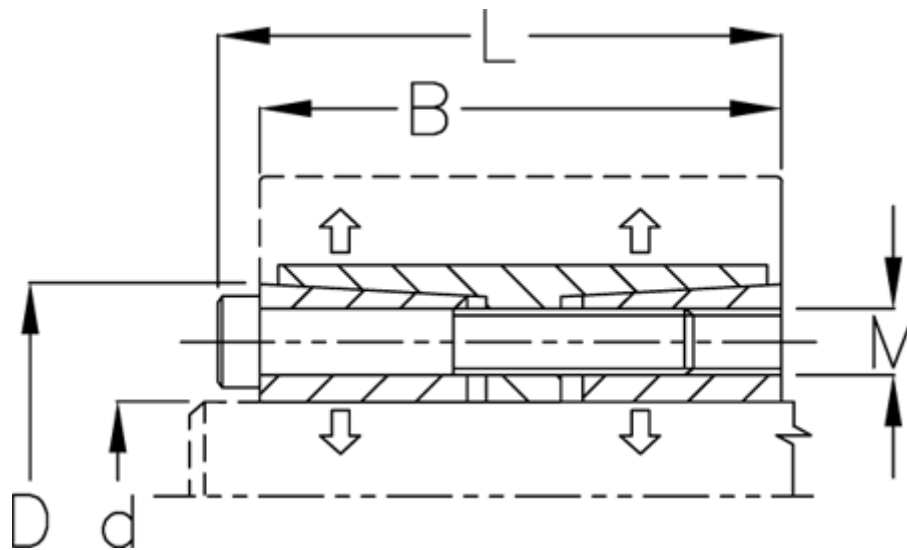

B mm	= 111
d H8 mm	= 280
D mm	= 355
Fit tolerance	= Aksel h8, Nav H8
F kN torque	= 1686.0
L mm	= 131
M mm	= M20
P N/mm <sup>2</sup> surface pressure on shaft/hub	= 166

Surface roughness	= R? ? 3.2 $\mu$ m
T N m torque	= 236000
Ts N m bolt tightening torque	= 690.0